

10 FT. CASITA® AIR CANOPY TENT

PRODUCT CATEGORY: OUTDOOR BANNER STAND

PRODUCT CODE: CAS-AIR10



On frame



On graphic



PRODUCT DESCRIPTION

Our Casita Canopy Tents™ are an excellent way to provide shade during outdoor and indoor events. These canopies are standard 10' x 10' size and are available in custom dye-sub print which has a high quality finish with vivid color. Set up is quick, easy and user friendly. Telescopic legs snap into place offering a range of heights. This kit includes a convenient travel bag with wheels to store your tent frame and graphic in between events.

DISPLAY DIMENSIONS	118" W x 138.5" H x 118" D
MIN HEIGHT	130.5" H
MAX HEIGHT	138.5" H
GRAPHIC SIZE	126" W x 87" H

GRAPHIC MATERIAL

Dye Sub Tent Fabric (UPF 50+ Rated Material)

GRAPHIC FINISHING

Hemmed around panels w/white or black trim on seams. Velcro sewn to insides of each valance corner and reinforcement sewn inside of peak.

DISPLAY CONSTRUCTION

Steel frame w/32mm dia square legs & plastic components

SHIPPING WEIGHTS & DIMENSIONS

Shipping Weight	57 lbs (frame and graphic)
Shipping Dimensions	69" L x 9.5" W x 9.5" H (oversize)

GRAPHIC TURN AROUND TIME

3 business days after proof approval (up to 2 sets)

AVAILABILITY	PFC
WIND SPEED RATING	20 - 28 mph

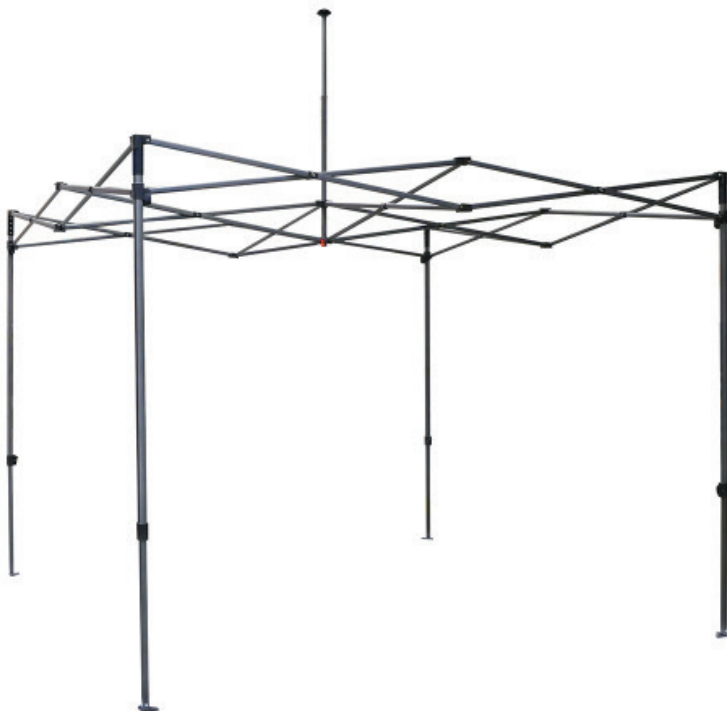

INCLUDES TRAVEL BAG W/WHEELS

CASITA CANOPY TENTS™ 10FT CLASSIC

PRODUCT CATEGORY: OUTDOOR BANNER STAND

PRODUCT CODE: CAS-CST10



On frame On graphic

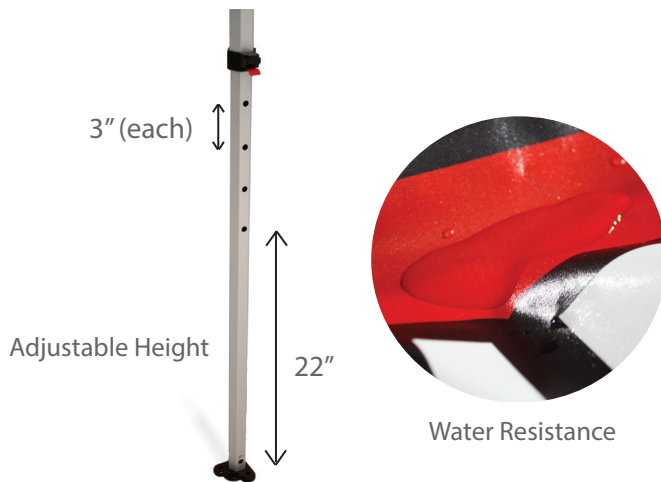

PRODUCT DESCRIPTION

Our Casita Canopy Tents™ are an excellent way to provide shade during outdoor and indoor events. These canopies are standard 10' x 10' size and are available in custom dye-sub print which has a high quality finish with vivid color. Set up is quick, easy and user friendly. Telescopic legs snap into place offering a range of heights. This classic system includes a protective dust cover to use while in storage.

DISPLAY DIMENSIONS	118.75"W x 135"H x 118.75"D
MIN HEIGHT	99" H
MAX HEIGHT	132" H
LOWEST SETTING TO PEAK	120.25" H
FLOOR TO LOWEST SETTING	22" H
GRAPHIC SIZE	126" W x 87" H

GRAPHIC MATERIAL

Dye Sub Tent Fabric (UPF 50+ Rated Material)

GRAPHIC FINISHING

Hemmed around panels w/white or black trim on seams. Velcro sewn to insides of each valance corner and reinforcement sewn inside of peak.

DISPLAY CONSTRUCTION

Aluminium frame w/40mm dia hex legs & plastic components

SHIPPING WEIGHTS & DIMENSIONS

Shipping Weight	53 lbs (stand only) 63 lbs (frame and graphic)
Shipping Dimensions	63"L x 11"W x 11"H (oversize)

LARGE QUANTITY FREIGHT

Freight Shipping	16 boxes per 48"L x 40"W x 67"H skid
Freight Weight	888 lbs (frame only + 40 lb skid) 1048 lbs (frame & graphic + 40 lb skid)

GRAPHIC TURN AROUND TIME

3 business days after proof approval (up to 2 sets)

AVAILABILITY	CA, PA, PFC
WIND SPEED RATING	20 - 28 mph



Crank for peak adjustment

CASITA CANOPY TENTS™ 10FT STEEL

PRODUCT CATEGORY: OUTDOOR BANNER STAND

PRODUCT CODE: CASTL-10



On frame On graphic

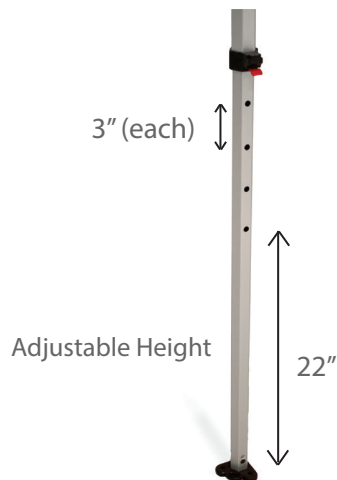

Water Resistance



PRODUCT DESCRIPTION

Our Casita Canopy Tents™ are an excellent way to provide shade during outdoor and indoor events. These canopies are standard 10' x 10' size and are available in custom dye-sub print which has a high quality finish with vivid color. Set up is quick, easy and user friendly. Telescopic legs snap into place offering a range of heights. This classic system includes a protective dust cover to use while in storage.

DISPLAY DIMENSIONS	118.75"W x 135"H x 118.75"D
MIN HEIGHT	99" H
MAX HEIGHT	132" H
LOWEST SETTING TO PEAK	120.25" H
FLOOR TO LOWEST SETTING	22" H
GRAPHIC SIZE	126" W x 87" H

GRAPHIC MATERIAL

Dye Sub Tent Fabric (UPF 50+ Rated Material)

GRAPHIC FINISHING

Hemmed around panels w/white or black trim on seams. Velcro sewn to insides of each valance corner and reinforcement sewn inside of peak.

DISPLAY CONSTRUCTION

Steel frame w/28mm dia square legs & plastic components

SHIPPING WEIGHTS & DIMENSIONS

Shipping Weight	58 lbs (stand only) 68 lbs (frame and graphic)
Shipping Dimensions	63"L x 11"W x 11"H (oversize)

LARGE QUANTITY FREIGHT

Freight Shipping	16 boxes per 48"L x 40"W x 67"H skid
Freight Weight	968 lbs (frame only +40 lb skid) 1128 lbs (frame & graphic + 40 lb skid)

GRAPHIC TURN AROUND TIME

3 business days after proof approval (up to 2 sets)

AVAILABILITY	CA, PA, PFC
WIND SPEED RATING	20 - 28 mph



Standard Travel Bag



Crank for peak adjustment

CASITA CANOPY TENTS™ 10FT HEAVY DUTY

PRODUCT CATEGORY: OUTDOOR BANNER STAND

PRODUCT CODE: CASDLX-CST10



On frame



On graphic

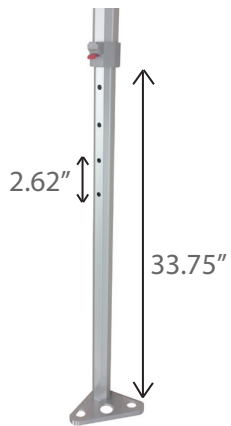

Adjustable Lever



Water Resistant Canopy



PRODUCT DESCRIPTION

The Heavy Duty Casita Canopy™ is our toughest tent yet! Dense aluminum construction makes it sturdy and most durable, especially for outdoor use. The frame is the standard 10' x 10' square and offers a range of heights. Each hexagonal leg has a 48mm girth. Springs in frame add tension to graphic for perfect fit and form.

DISPLAY DIMENSIONS	118.75"W x 142"H x 118.75"D
MIN HEIGHT	100" H
MAX HEIGHT	142" H
LOWEST SETTING TO PEAK	120.25" H
FLOOR TO LOWEST SETTING	22" H
GRAPHIC SIZE	126" W x 87" H

GRAPHIC MATERIAL

Dye Sub Tent Fabric (UPF 50+ Rated Material)

GRAPHIC FINISHING

Hemmed around panels w/white or black trim on seams. Velcro sewn to insides of each valance corner and reinforcement sewn inside of peak.

DISPLAY CONSTRUCTION

Aluminium frame w/48mm dia hex legs & plastic components

SHIPPING WEIGHTS & DIMENSIONS

Shipping Weight (frame)	63 lbs (stand only) 73 lbs (frame and graphic)
Shipping Weight (bag)	8 lbs
Shipping Dimensions (frame)	68"L x 13"W x 13"H (oversize)
Shipping Dimensions (bag)	17"L x 6"W x 17"H

GRAPHIC TURN AROUND TIME

3 business days after proof approval (up to 2 sets)

AVAILABILITY	CA, PA, PFC
WIND SPEED RATING	20 - 28 mph



Includes travel bag with wheels

CASITA CANOPY TENTS™ 5FT CLASSIC

PRODUCT CATEGORY: OUTDOOR BANNER STAND

PRODUCT CODE: CAS-5FT



On frame On graphic



PRODUCT DESCRIPTION

Our Casita Canopy Tents™ are an excellent way to provide shade during outdoor and indoor events. These canopies are standard 5' x 5' size and are available in custom dye-sub print which has a high quality finish with vivid color. Set up is quick, easy and user friendly. Telescopic legs snap into place offering a range of heights. This classic system includes a protective dust cover to use while in storage.

DISPLAY DIMENSIONS	59.75"W x 103.5"H x 59.75"D
MIN HEIGHT	69" H
MAX HEIGHT	103.25" H
LOWEST SETTING TO PEAK	90.75" H
FLOOR TO LOWEST SETTING	22.5" H
GRAPHIC SIZE	60.25"W x 49"H

GRAPHIC MATERIAL

Dye Sub Tent Fabric (UPF 50+ Rated Material)

GRAPHIC FINISHING

Hemmed around panels w/white or black trim on seams. Velcro sewn to insides of each valance corner and reinforcement sewn inside of peak.

DISPLAY CONSTRUCTION

Steel frame w/28mm dia square legs & plastic components

SHIPPING WEIGHTS & DIMENSIONS

Shipping Weight	32 lbs (stand only) 39 lbs (frame and graphic)
Shipping Dimensions	63"L x 10"W x 10"H (oversize)

LARGE QUANTITY FREIGHT

Freight Shipping	28 boxes per 48"L x 40"W x 74"H skid
Freight Weight	936 lbs (frame only +40 lb skid) 1132 lbs (frame & graphic + 40 lb skid)

GRAPHIC TURN AROUND TIME

3 business days after proof approval (up to 2 sets)

AVAILABILITY	CA, PA, PFC
WIND SPEED RATING	20 - 28 mph



Standard Travel Bag



CASITA CANOPY TENTS™ 15FT CLASSIC

PRODUCT CATEGORY: OUTDOOR BANNER STAND

PRODUCT CODE: CAS-CST15



On frame On graphic

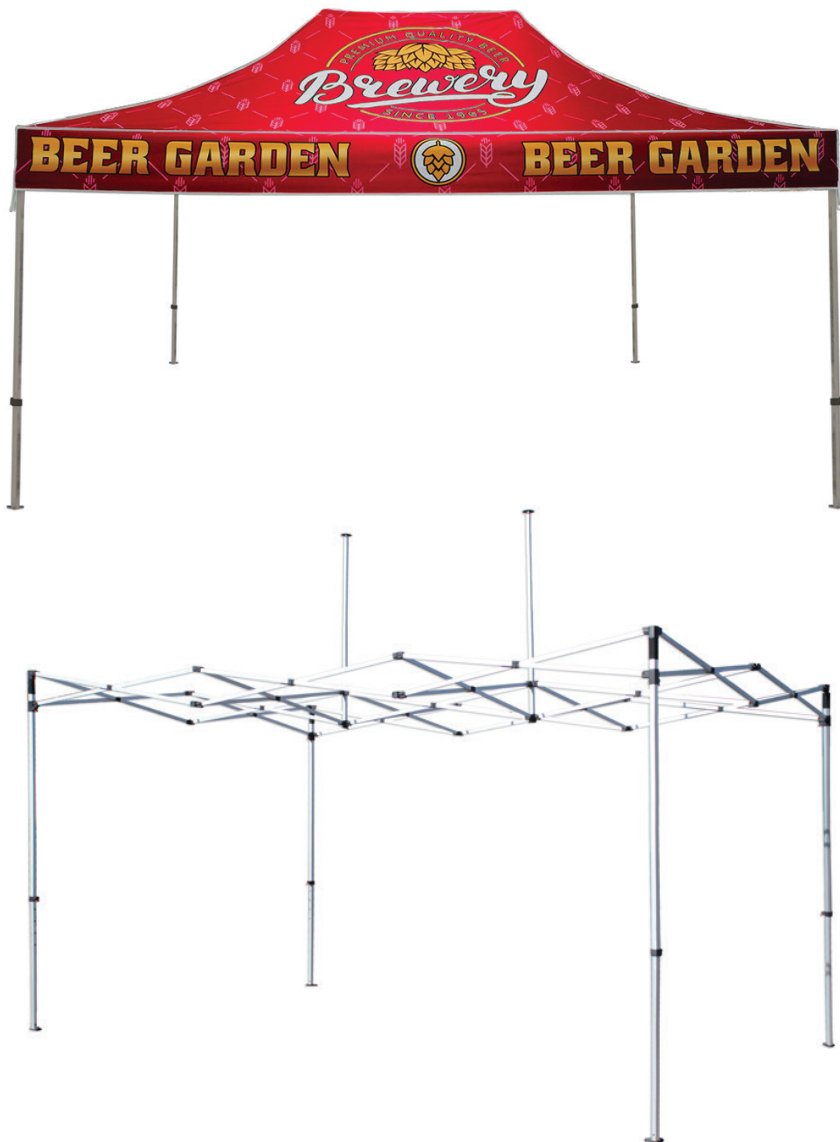

PRODUCT DESCRIPTION

Our Casita Canopy Tents™ are an excellent way to provide shade during outdoor and indoor events. These canopies are standard 15' x 10' size and are available in custom dye-sub print which has a high quality finish with vivid color. Set up is quick, easy and user friendly. Telescopic legs snap into place offering a range of heights. This classic system includes a protective dust cover to use while in storage.

DISPLAY DIMENSIONS	176"W x 135"H x 118.75"D
MIN HEIGHT	99" H
MAX HEIGHT	132" H
LOWEST SETTING TO PEAK	120.25" H
FLOOR TO LOWEST SETTING	22" H
GRAPHIC SIZE 15FT SIDE	176"W x 89"H
GRAPHIC SIZE 10FT SIDE	120.5"W x 90"H

GRAPHIC MATERIAL

Dye Sub Tent Fabric (UPF 50+ Rated Material)

GRAPHIC FINISHING

Hemmed around panels w/white or black trim on seams. Velcro sewn to insides of each valance corner and reinforcement sewn inside of peak.

DISPLAY CONSTRUCTION

Aluminium frame w/40mm dia hex legs & plastic components

SHIPPING WEIGHTS & DIMENSIONS

Shipping Weight	67 lbs (stand only) 82 lbs (frame and graphic)
Shipping Dimensions	63"L x 11"W x 14"H (oversize)

LARGE QUANTITY FREIGHT

Freight Shipping	16 boxes per 48"L x 40"W x 67 "H skid
Freight Weight	1112 lbs (frame only + 40 lb skid) 1352 lbs (frame & graphic + 40 lb skid)

GRAPHIC TURN AROUND TIME

3 business days after proof approval (up to 2 sets)

AVAILABILITY	CA, PA, PFC
WIND SPEED RATING	20 - 28 mph

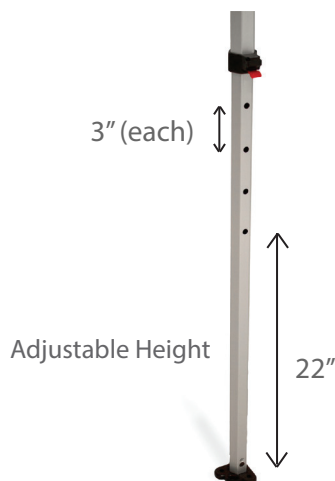

Water Resistance



Standard Travel Bag



Crank for peak adjustment

CASITA CANOPY TENTS™ 20FT CLASSIC

PRODUCT CATEGORY: OUTDOOR BANNER STAND

PRODUCT CODE: CAS-CST20



On frame



On graphic

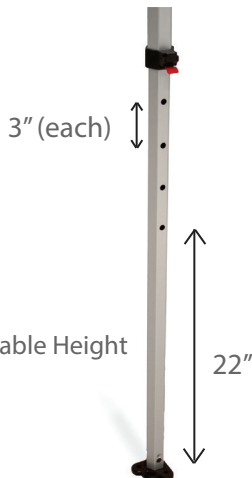
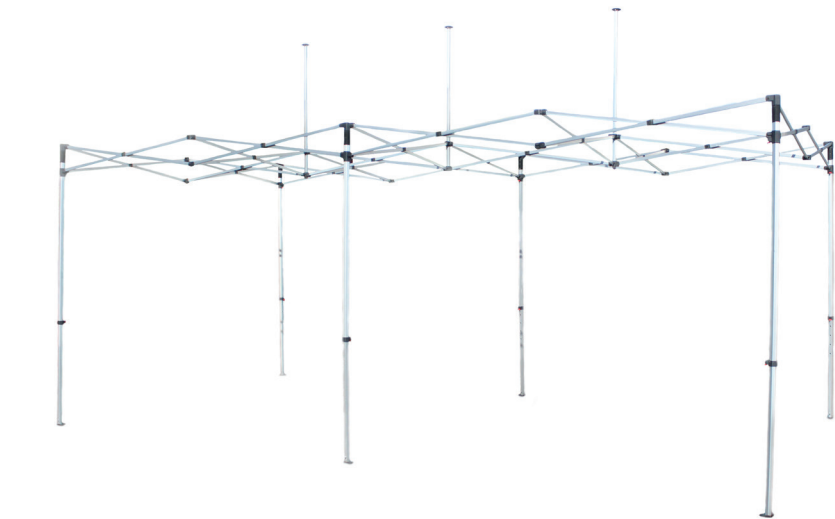

Water Resistance



Standard Travel Bag



Crank for peak adjustment

PRODUCT DESCRIPTION

Our Casita Canopy Tents™ are an excellent way to provide shade during outdoor and indoor events. These canopies are standard 20' x 10' size and are available in custom dye-sub print which has a high quality finish with vivid color. Set up is quick, easy and user friendly. Telescopic legs snap into place offering a range of heights. This classic system includes a protective dust cover to use while in storage.

DISPLAY DIMENSIONS	232" W x 135" H x 118.75" D
MIN HEIGHT	99" H
MAX HEIGHT	132" H
LOWEST SETTING TO PEAK	120.25" H
FLOOR TO LOWEST SETTING	22" H
GRAPHIC SIZE 20FT SIDE	233"W x 87"H
GRAPHIC SIZE 10FT SIDE	119.5"W x 87.675"H

GRAPHIC MATERIAL

Dye Sub Tent Fabric (UPF 50+ Rated Material)

GRAPHIC FINISHING

Hemmed around panels w/white or black trim on seams. Velcro sewn to insides of each valance corner and reinforcement sewn inside of peak.

DISPLAY CONSTRUCTION

Aluminium frame w/40mm dia hex legs & plastic components

SHIPPING WEIGHTS & DIMENSIONS

Shipping Weight	70 lbs (stand only) 88 lbs (frame and graphic)
Shipping Dimensions	63"L x 11"W x 18"H (oversize)

LARGE QUANTITY FREIGHT

Freight Shipping	16 boxes per 48"L x 40"W x 67"H skid
Freight Weight	1160 lbs (frame only + 40 lb skid) 1448 lbs (frame & graphic + 40 lb skid)

GRAPHIC TURN AROUND TIME

3 business days after proof approval (up to 2 sets)

AVAILABILITY	CA, PA, PFC
WIND SPEED RATING	20 - 28 mph



On frame



On graphic



PARTS LIST (ALL SIZES)



(qty 1)

Tent Frame*

*Size Varies



(qty 1)

Travel Bag*

*Size Varies



On frame



On graphic



AVAILABLE ACCESSORIES



10ft Wheeled Bag
CAS-BAGWHL



15ft/20ft Wheeled Bag
CAS-BAGWHL15/20



La Caja Hardcase
LACAJA



Ropes & Stakes
CAS-RS



Sand Bag Cover
CAS-SBAG



Plastic Water Base
CAS-SQR-BASE



Feather Flag Connector
CAS-FLGCNCT



Falcon Flag Connector 0°
FAL-FM0D (flag mount)
FAL-FLGCNCT (back plate)



SKU Falcon Flag Connector 30°
FAL-FM30D (flag mount)
FAL-FLGCNCT (back plate)



On frame



On graphic



TEMPLATES

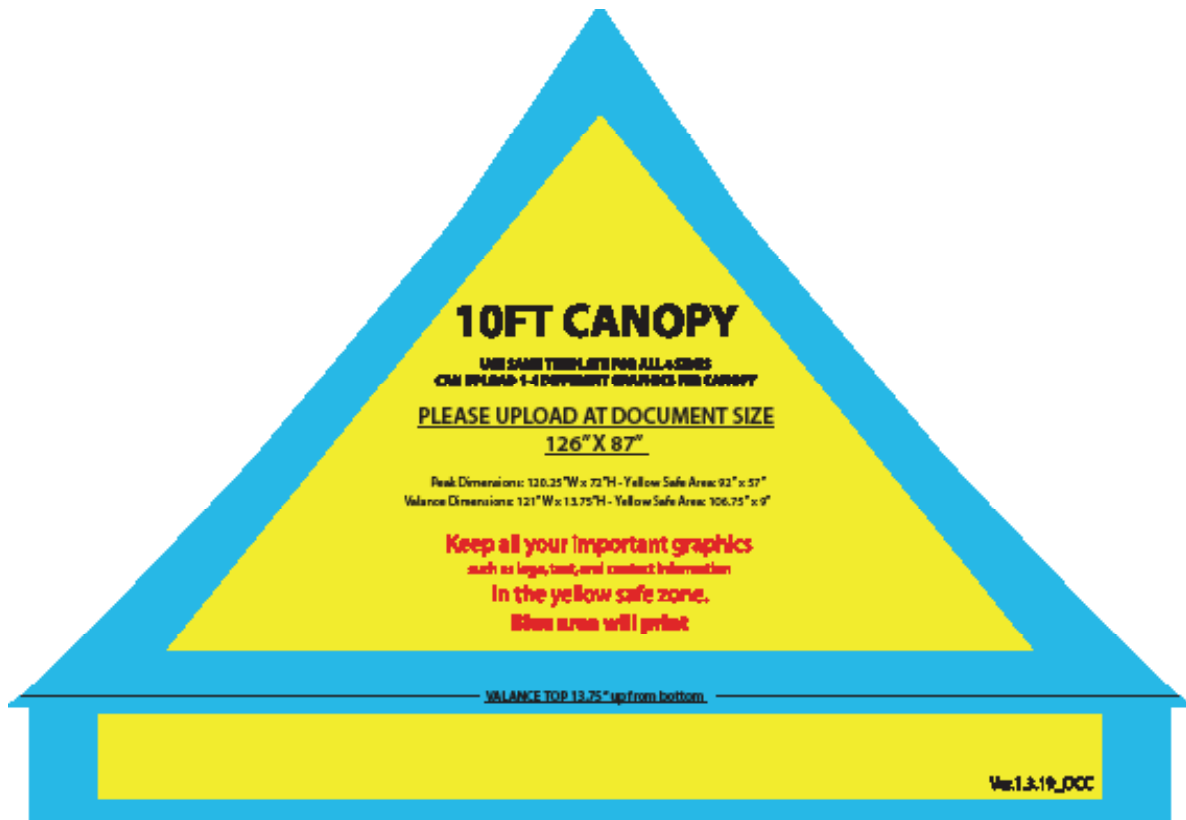
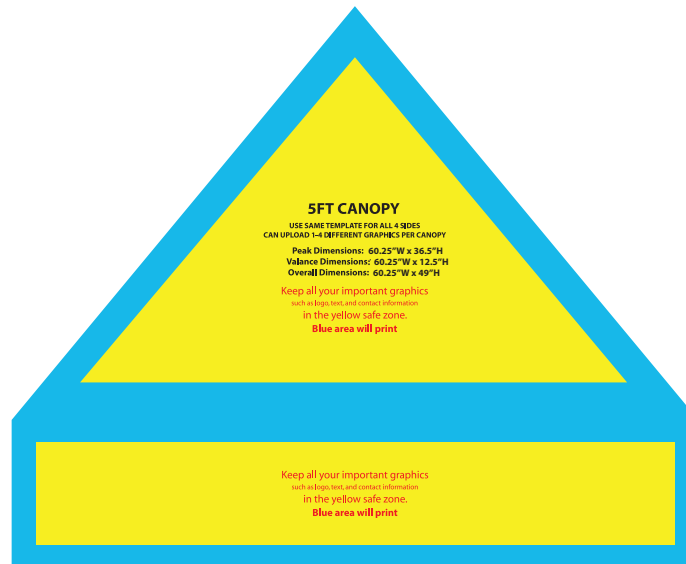



On frame

On graphic

TEMPLATE

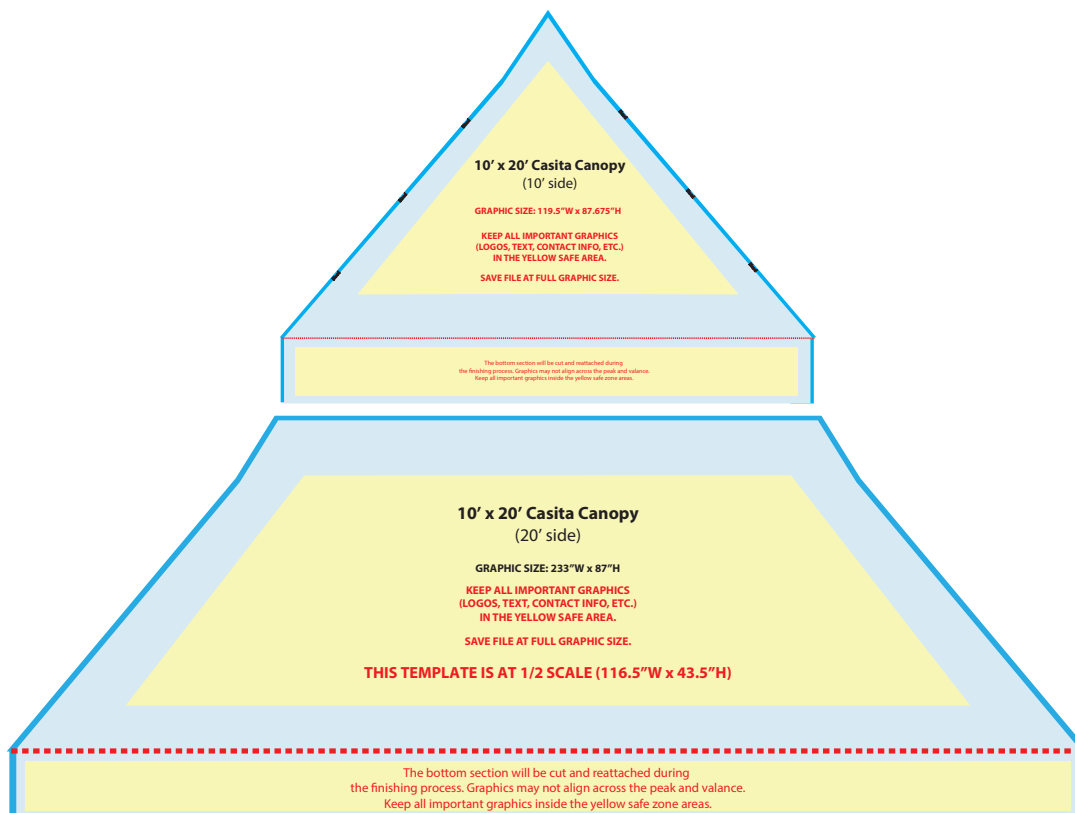
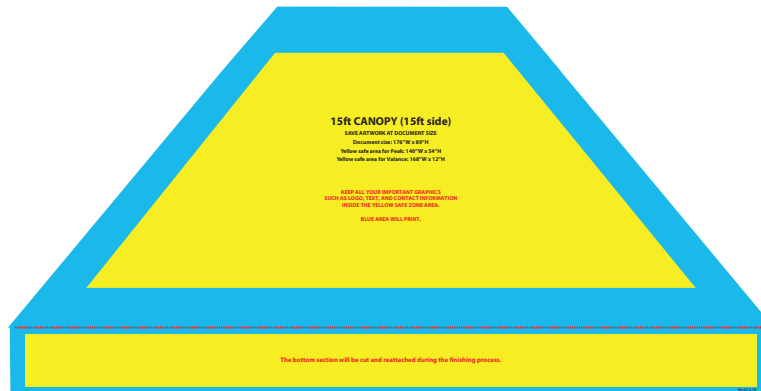
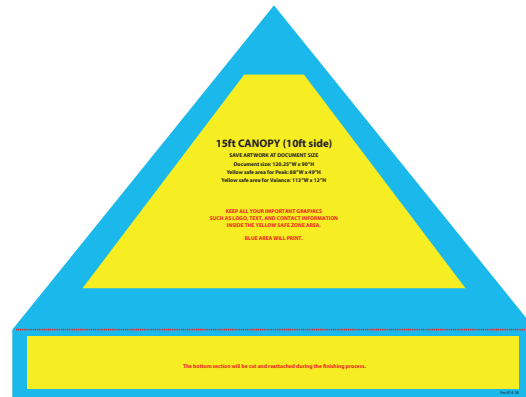



On frame



On graphic



SET UP INSTRUCTIONS

Step 1

Take your frame and slightly expand it open to expose the corner bars.



Step 2

Take your canopy graphic and place it on top of the frame.



Step 3

Adhere each corner of the canopy to each corner of the frame. Inside each corner of the canopy, there is a strip of loop Velcro sewn to it and each corner of the frame has a strip of hook Velcro.



Step 4

With the canopy securely in position, expand the frame until the corner latches lock into place.

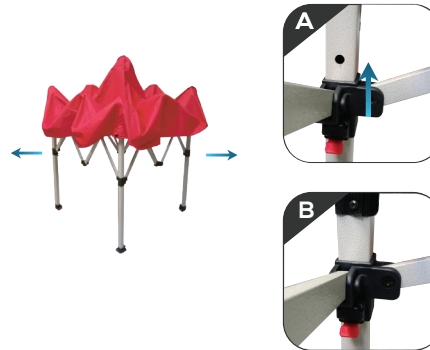

Step 5

Increase the height by extending the lower legs.



Step 6

Pull each leg down until the latch locks into place.



Step 7

Locate the spindle under the canopy, in the middle of the frame. Pull the lever out and rotate to extend the upper peak pole. The dome cap will push out the canopy creating tension to flush out any loose areas.



Step 8

The install is complete.

